

Cabin Stove Foundation Details

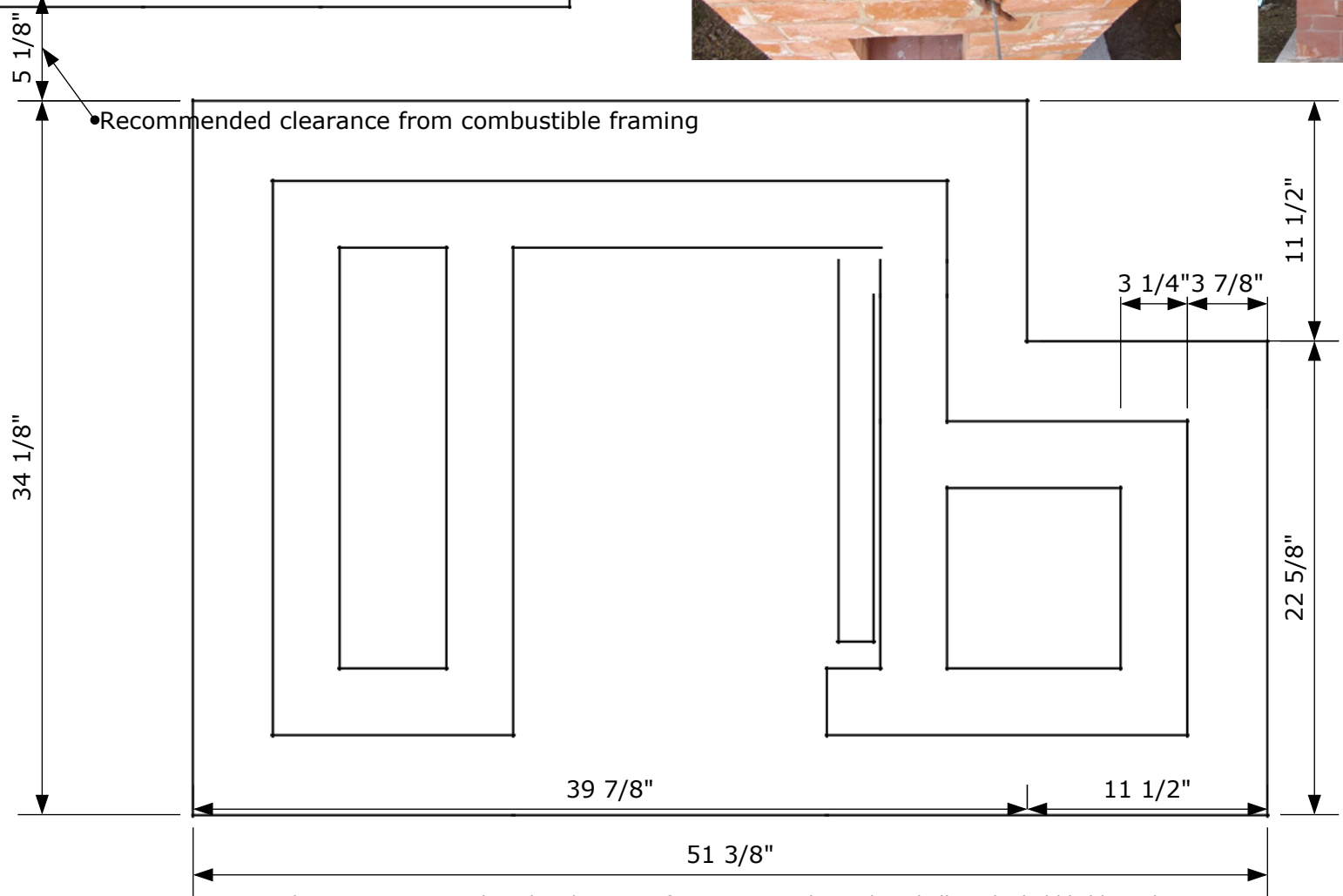

Firespeaking - www.firespeaking.com - info@firespeaking.com - 541-964-5556

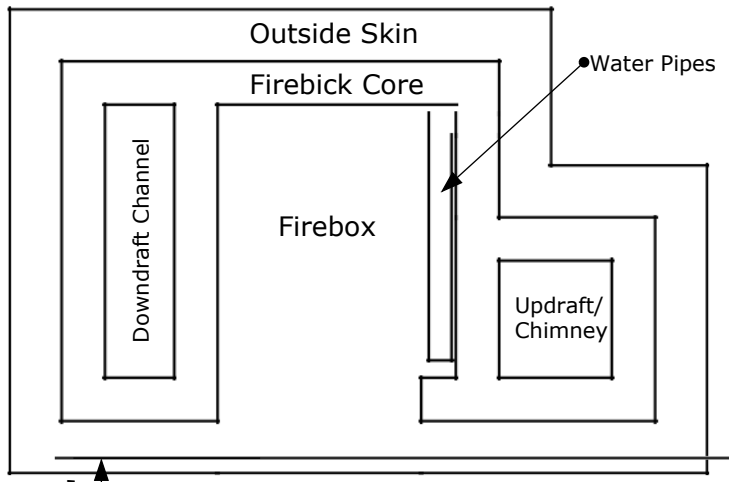

Chimney Placement Detail

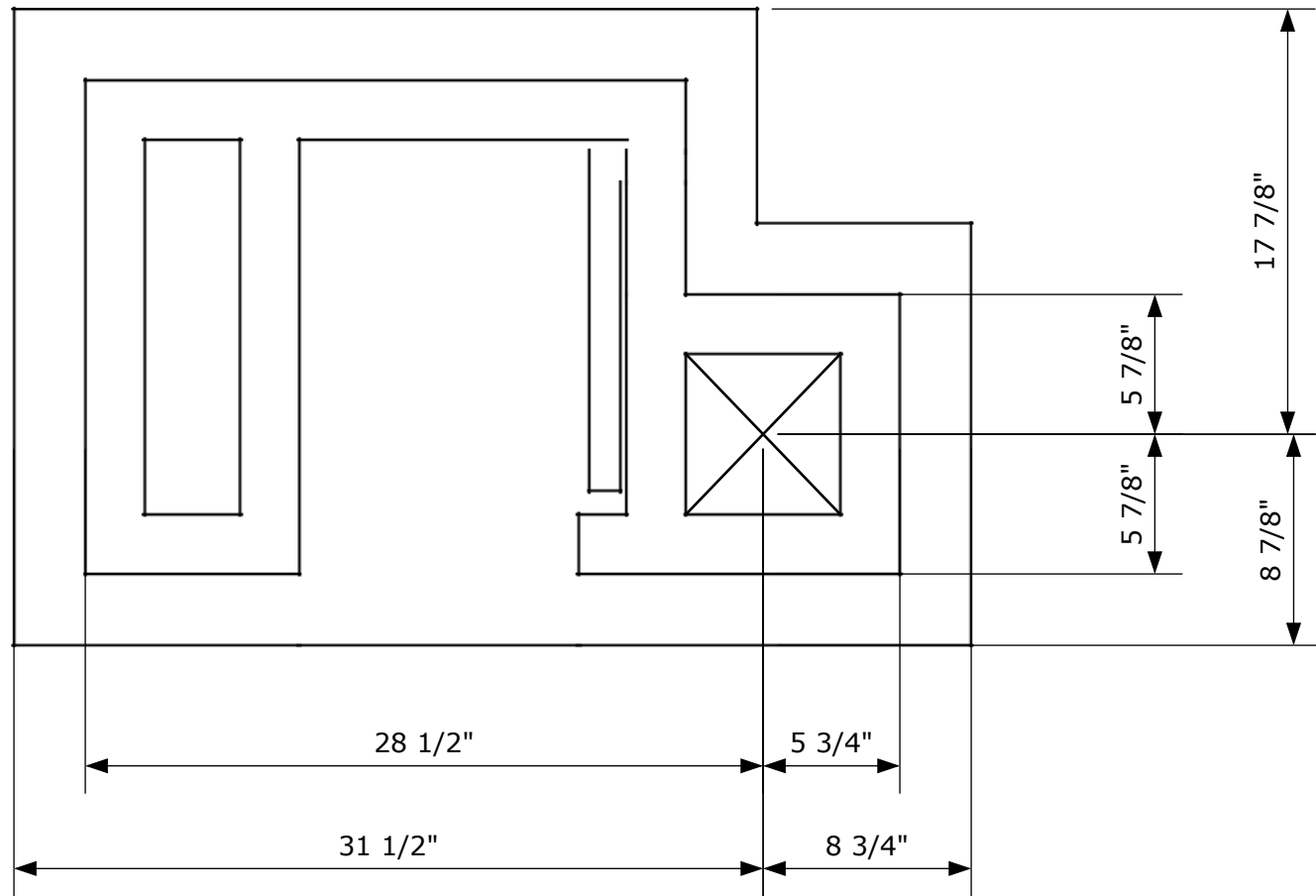

Layout of Heater

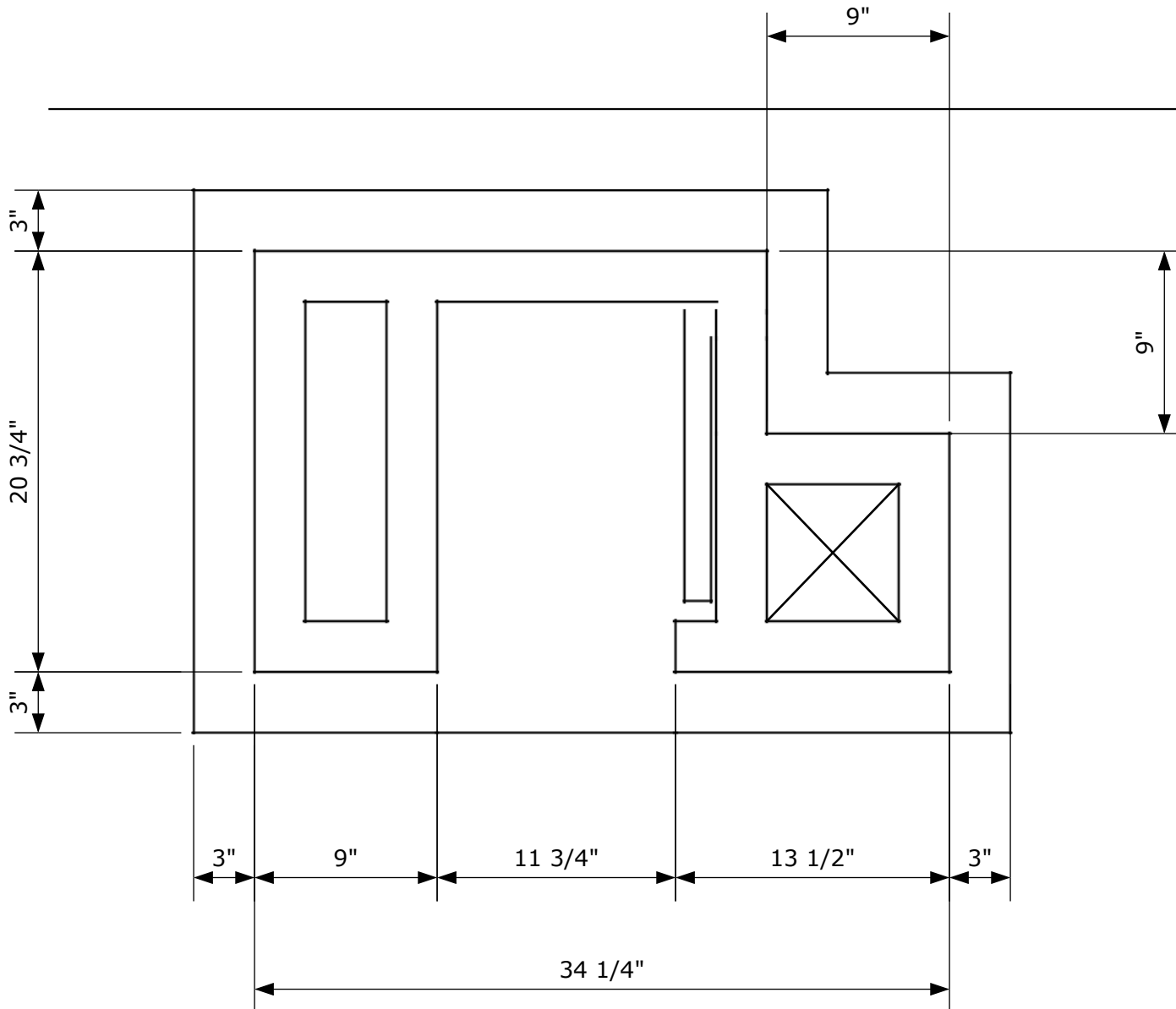

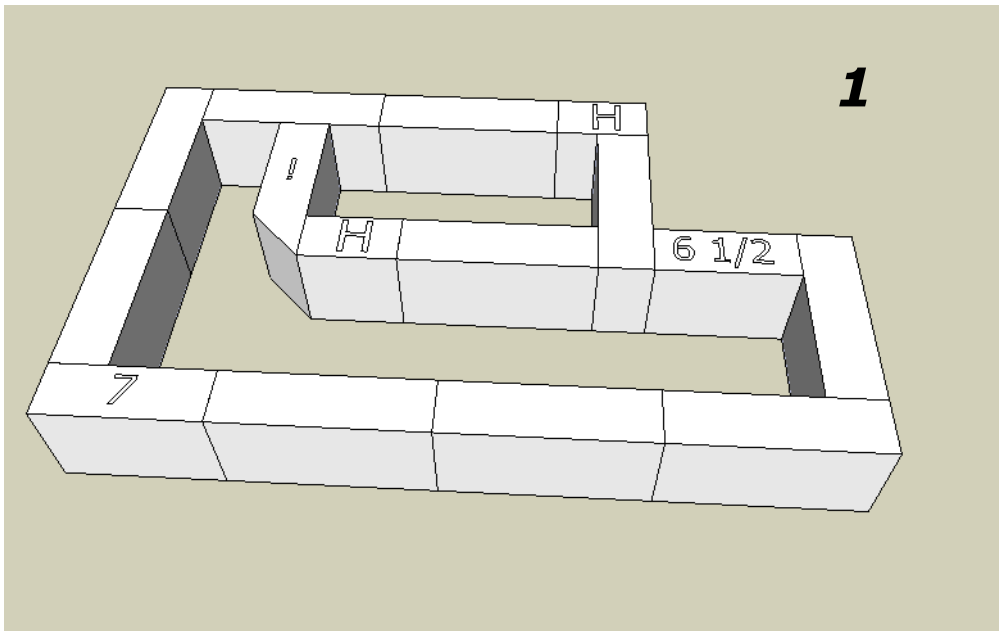

1

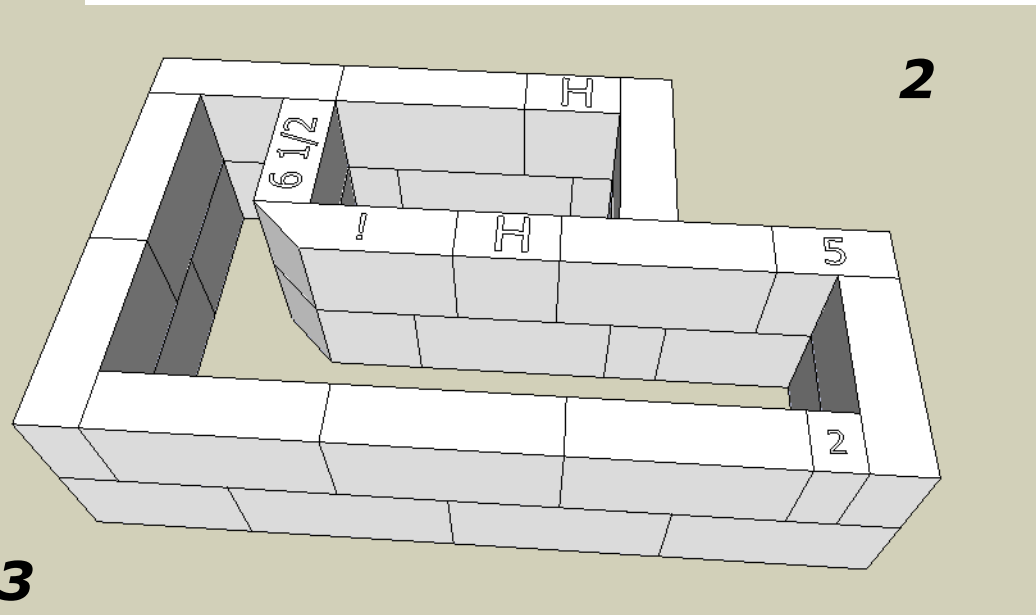

2

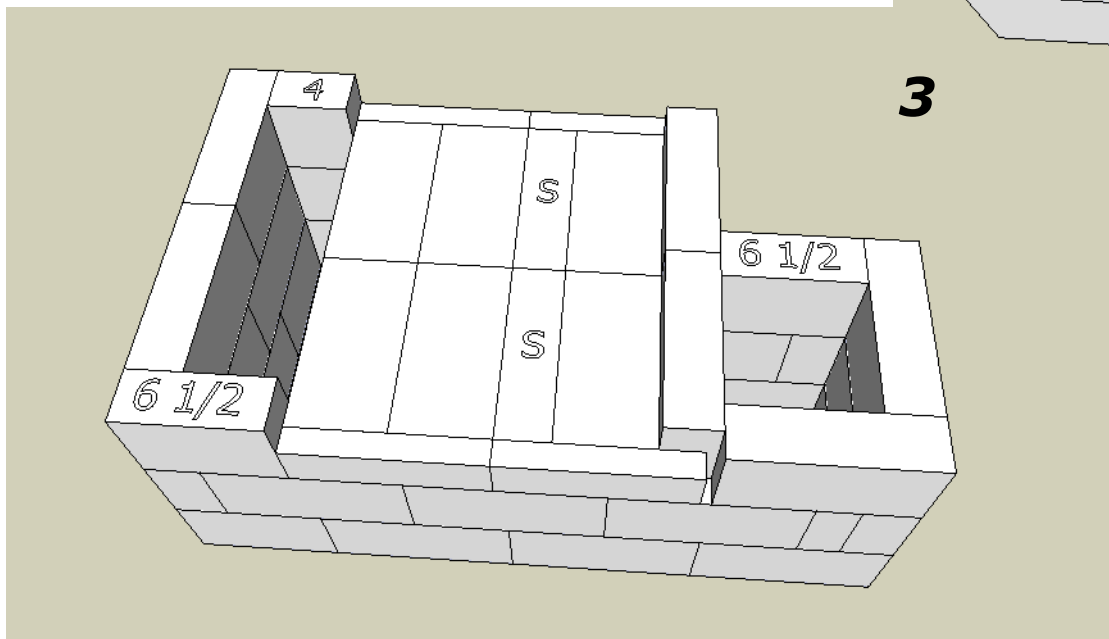

3



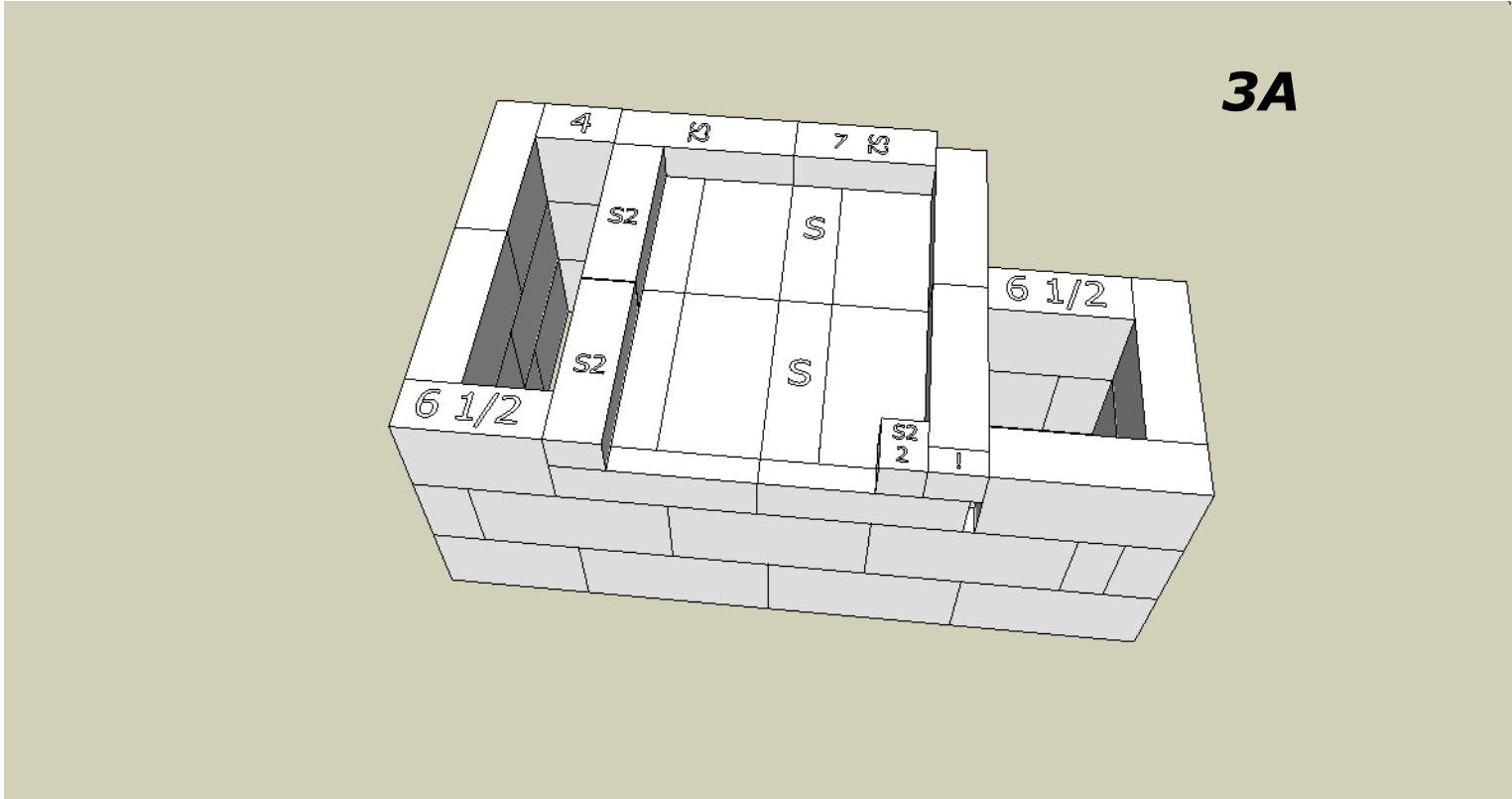

3A

Firespeaking - www.firespeaking.com - info@firespeaking.com - 541-964-5556



4

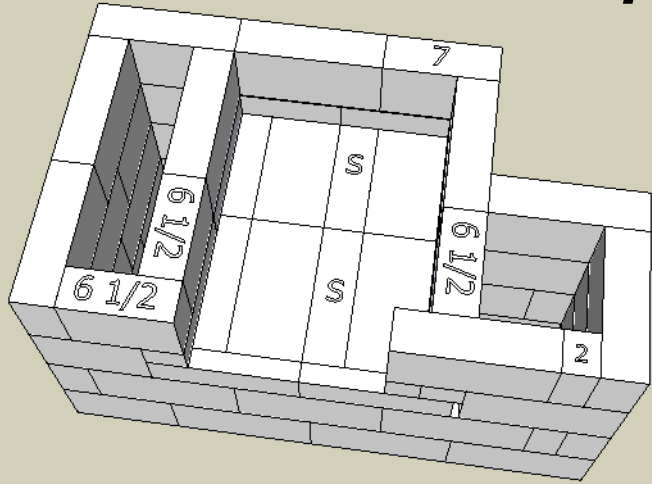

5

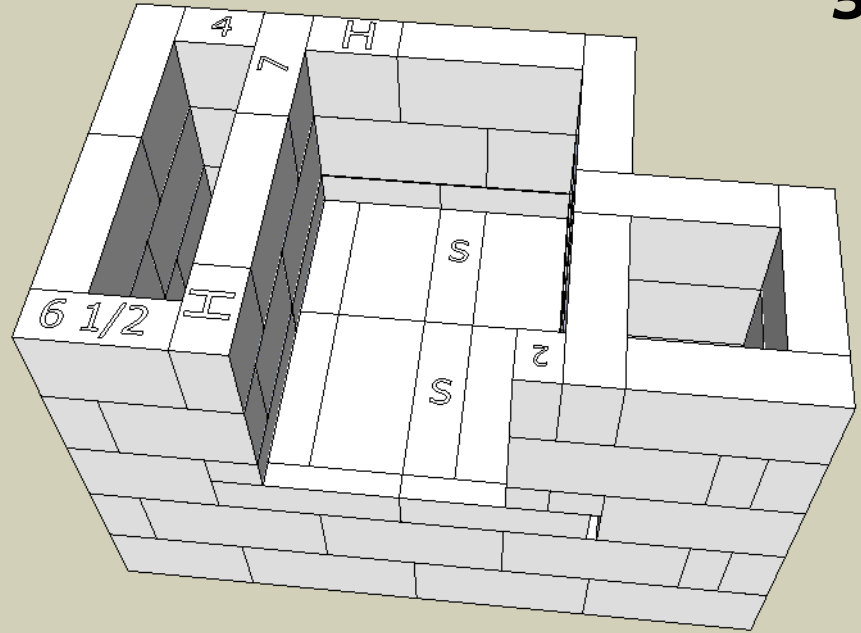

6

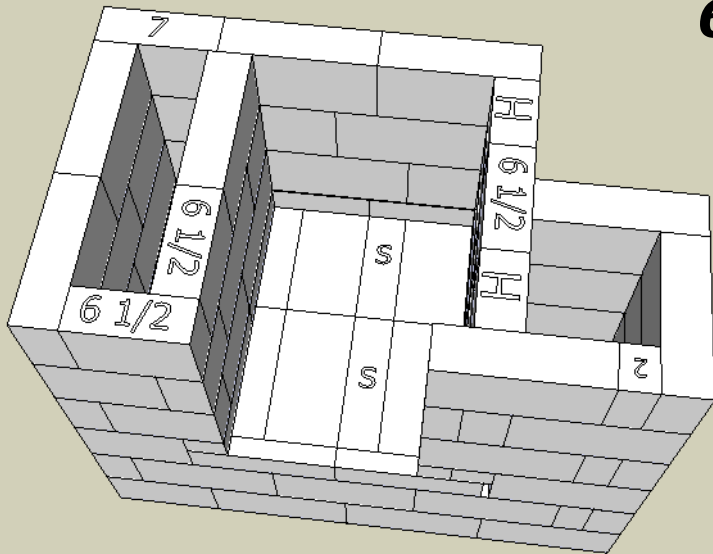

Firespeaking - www.firespeaking.com - info@firespeaking.com - 541-964-5556



Dimensions for Serpentine A

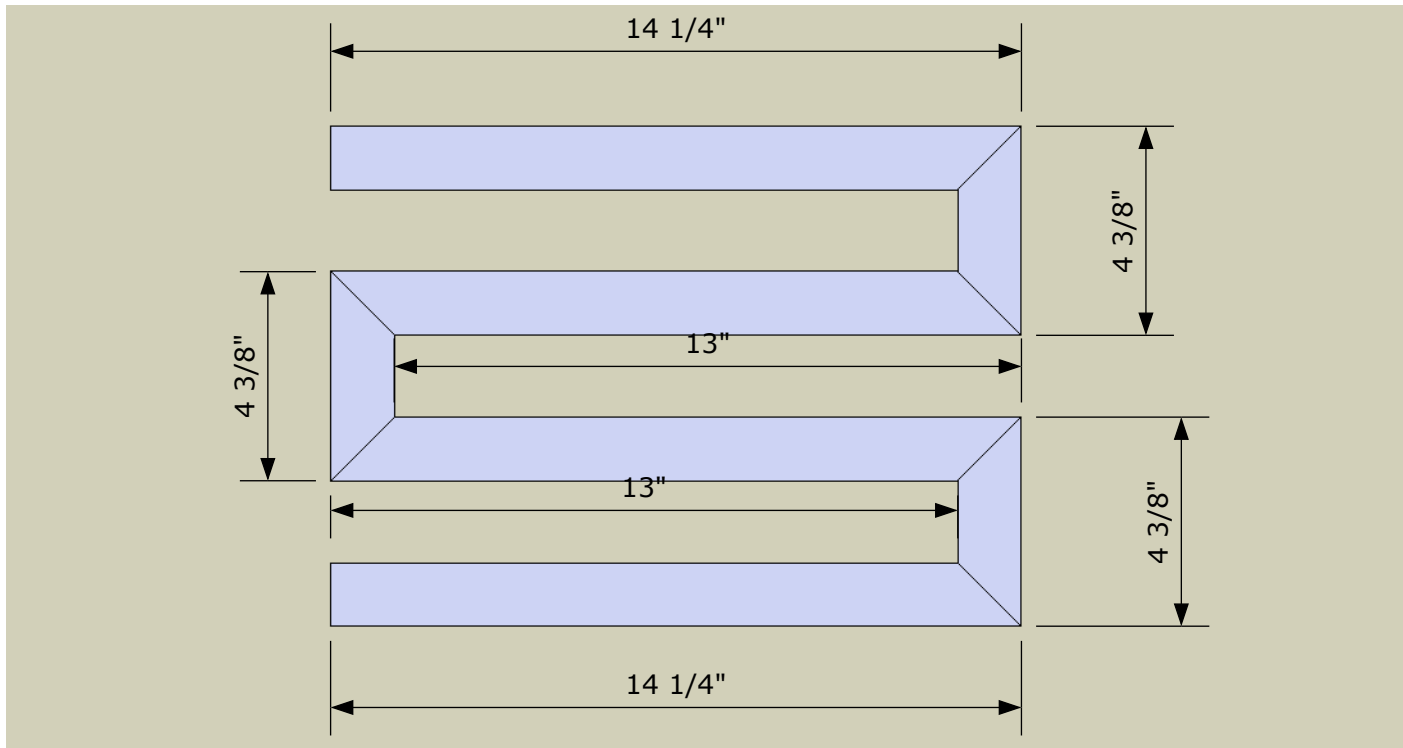

Firespeaking - www.firespeaking.com - info@firespeaking.com - 541-964-5556



Dimensions for Serpentine B

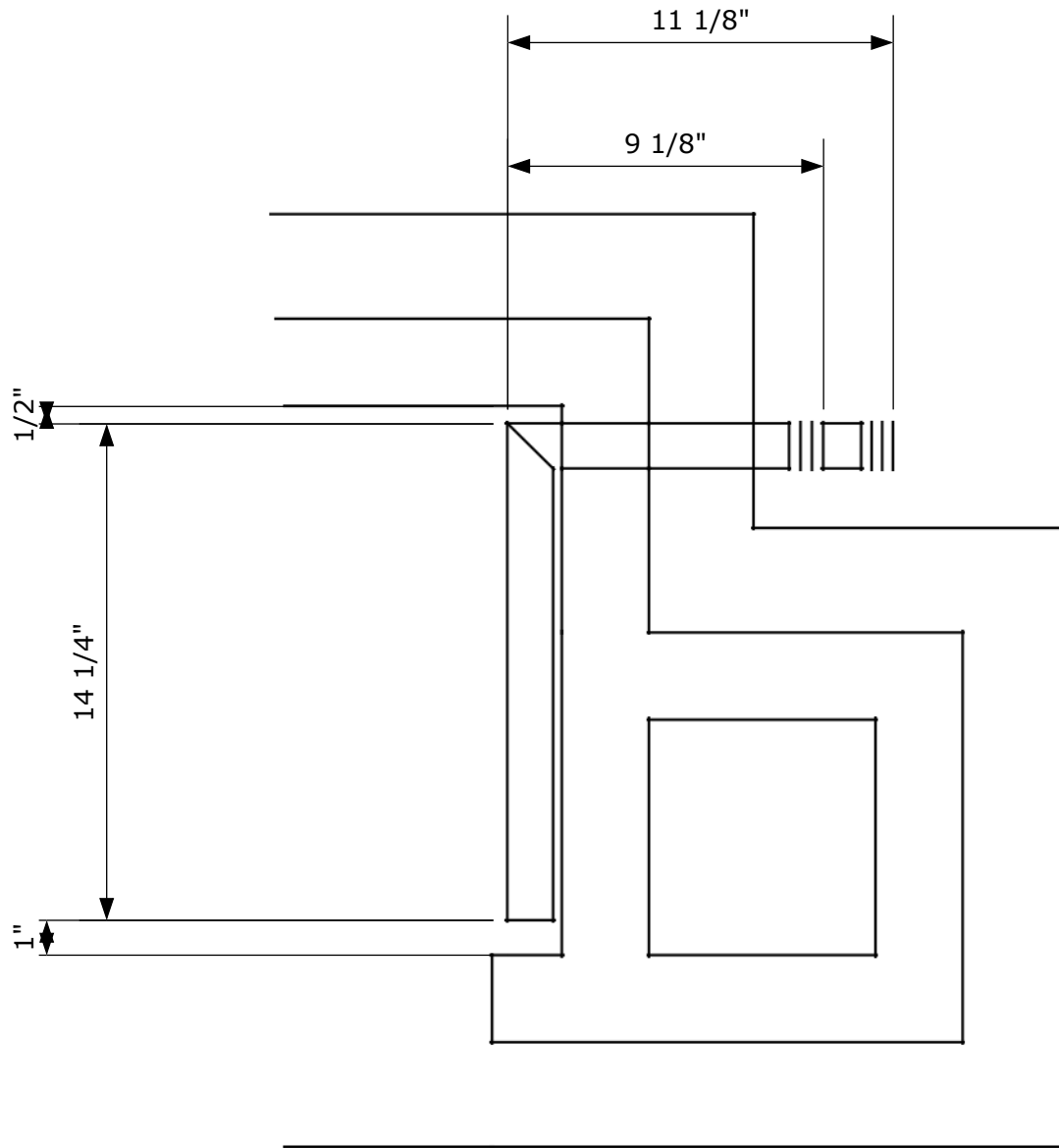

Firespeaking - www.firespeaking.com - info@firespeaking.com - 541-964-5556



Arch Form Construction Details

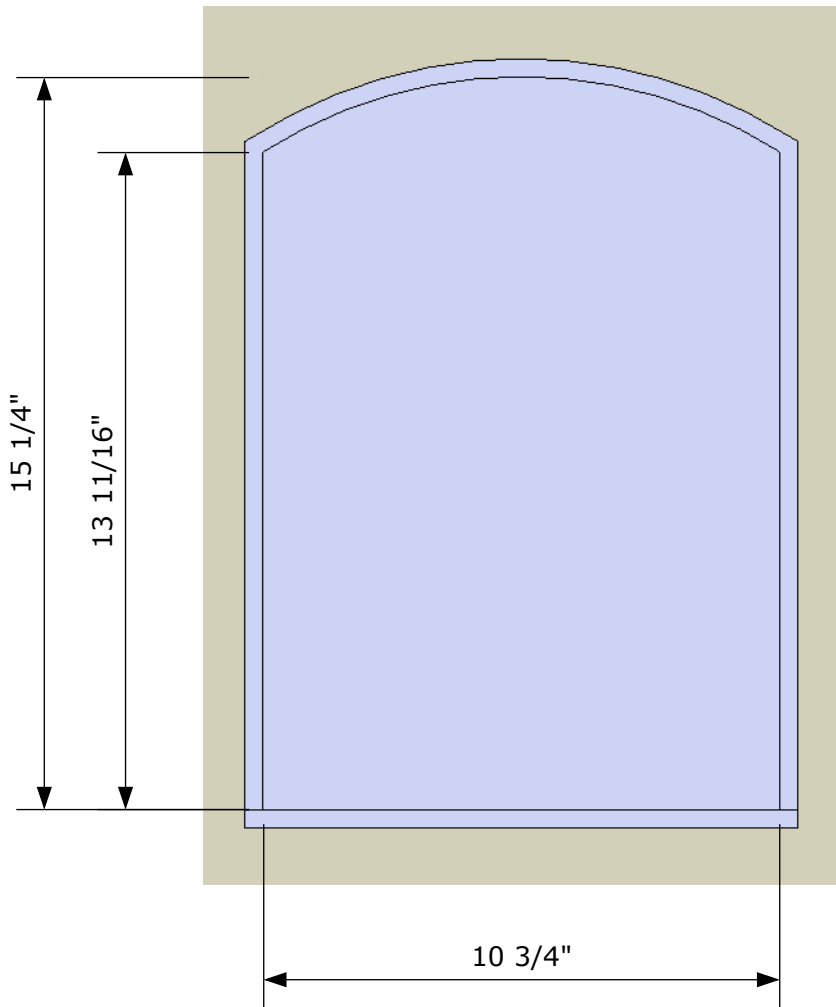

Outside Door Frame Dimensions

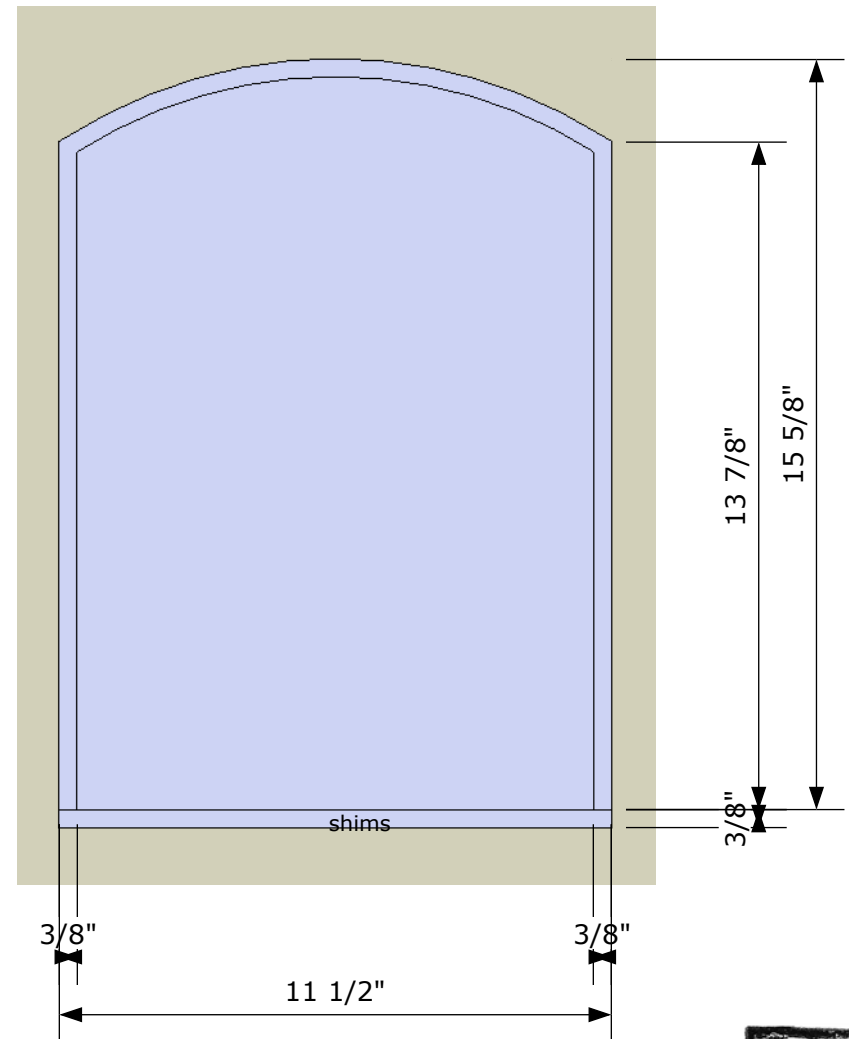

Firespeaking - www.firespeaking.com - info@firespeaking.com - 541-964-5556

